

BEST CARBIDE



www.minosrl.com

commerciale@minosrl.com

Tel. +39 089 337885

PROMO

DAL 01/04/2019

AL 31/05/2019

I PREZZI DEGLI ARTICOLI
"SUPER-PROMO"
SARANNO APPLICABILI
FINO AD ESAURIMENTO
SCORTE

301 – Utilizzo Generico - Lunghezza Standard



Z2 *a richiesta	Z3 *a richiesta	Z4 *a richiesta	D1	D2	L1	L2	Riv. A AITIN	NON RIV
*301-2010-A	*301-3010-A	*301-4010-A	1	3	38	4	9,07	
*301-2015-A	*301-3015-A	*301-4015-A	1.5	3	38	4.5	9,07	
*301-2020-A	*301-3020-A	*301-4020-A	2	3	38	6.3	9,07	
*301-2025-A	*301-3025-A	*301-4025-A	2.5	3	38	9.5	9,07	
*301-2030-A	*301-3030-A	*301-4030-A	3	3	38	12	8,77	
*301-2035-A	*301-3035-A	301-4035-A	3.5	4	50	12	11,51	
*301-2040-A	301-3040-A	*301-4040-A	4	4	50	14	11,51	
*301-2045-A	301-3045-A	301-4045-A	4.5	6	50	16	14,01	
*301-2050-A	301-3050-A	*301-4050-A	5	6	50	16	14,01	
*301-2060-A	301-3060-A	*301-4060-A	6	6	50	19	14,54	
*301-2070-A	301-3070-A	*301-4070-A	7	8	63	19	18,66	
*301-2080-A	301-3080-A	*301-4080-A	8	8	63	20	19,20	
*301-2090-A	301-3090-A	*301-4090-A	9	10	75	22	35,61	
*301-2100-A	301-3100-A	*301-4100-A	10	10	75	22	35,61	
*301-2110-A	301-3110-A	*301-4110-A	11	12	75	25	39,77	
*301-2120-A	301-3120-A	*301-4120-A	12	12	75	25	41,57	
*301-2130-A	*301-3130-A	*301-4130-A	13	13	89	26	69,07	
*301-2140-A	301-3140-A	*301-4140-A	14	14	89	32	69,07	
*301-2150-A	*301-3150-A	*301-4150-A	15	16	89	32	77,83	
*301-2160-A	301-3160-A	*301-4160-A	16	16	89	32	77,83	
*301-2180-A	*301-3180-A	*301-4180-A	18	18	100	38	109,29	
*301-2190-A	*301-3190-A	*301-4190-A	19	19	100	38	122,90	
*301-2200-A	*301-3200-A	*301-4200-A	20	20	100	38	171,33	
*301-2250-A	*301-3250-A	*301-4250-A	25	25	100	38	220,10	
SUPER PROMO VALIDA FINO AD ESAURIMENTO SCORTE:								
	301-3030-A		3.5	4	50	12	7,14	
		301-4035-A	3.5	4	50	12	7,14	
	301-3040-A		4	4	50	14	7,14	
		301-4045-A	4.5	6	50	16	8,57	
301-2050-A			5	6	50	16	8,57	
	301-3060		6	6	50	19		5,71
	301-3070-A		7	8	63	19	11,43	
	301-3090-A		9	10	75	22	14,29	
301-2100			10	10	75	22		14,29
301-2110			11	12	75	25		14,29
	301-3120-A		12	12	75	25	28,57	
	301-3130-A		13	13	89	26	35,71	
301-2140-A			14	14	89	32	35,71	
	301-3160-A		16	16	89	32	35,71	
301-2200			20	20	100	38	7,14	35,71

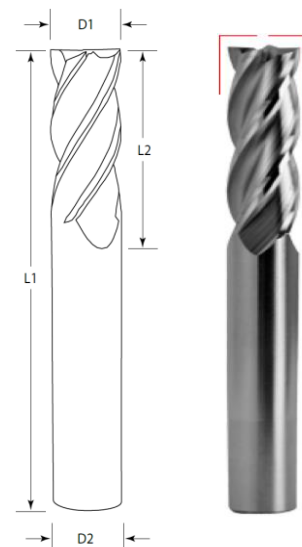

302 – Utilizzo Generico – Lunghezza Standard



Z2 *a richiesta	Z3 *a richiesta	Z4 *a richiesta	D1	D2	L1	L2	CR	Riv. A AITIN
SUPER PROMO VALIDA FINO AD ESAURIMENTO SCORTE								
302-2020-02-A	302-3020-02-A	*302-4020-02-A	2	4	50	5	0.2	8,57
302-2030-02-A	302-3030-02-A	*302-4030-02-A	3	6	50	8	0.2	8,57
302-2040-02-A	302-3040-02-A	*302-4040-02-A	4	6	50	11	0.2	8,57
302-2050-02-A	302-3050-02-A	*302-4050-02-A	5	6	50	16	0.2	8,57
302-2060-02-A	302-3060-02-A	*302-4060-02-A	6	6	50	16	0.2	11,43
302-2080-02-A	302-3080-02-A	*302-4080-02-A	8	8	63	22	0.2	14,29
302-2100-02-A	302-3100-02-A	*302-4100-02-A	10	10	75	25	0.2	21,43
302-2120-02-A	302-3120-02-A	*302-4120-02-A	12	12	75	30	0.2	21,43

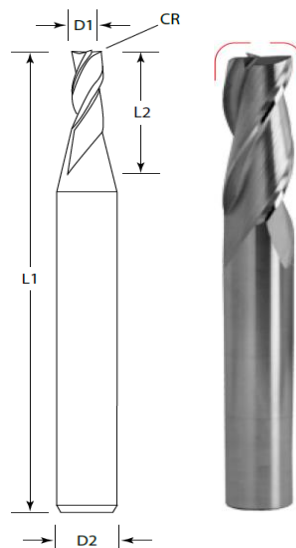

371 – Alluminio – Lunghezza Standard – HSC – Super Precise

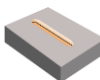

Z2 *a richiesta	Z3 *a richiesta	D1	D2	L1	L2	Non Rivestite
*371-2010		1	4	50	3	17,34
*371-2020		2	4	50	6	17,34
*371-2030		3	6	50	10	21,89
*371-2040	371-3040	4	6	50	15	21,89
*371-2050	371-3050	5	6	50	20	21,89
*371-2060	371-3060	6	6	50	20	21,89
*371-2080	371-3080	8	8	63	25	27,11
*371-2100	371-3100	10	10	75	25	35,76
*371-2120	371-3120	12	12	75	30	51,00
*371-2140	371-3140	14	14	75	30	61,56
*371-2160	371-3160	16	16	89	35	98,81
*371-2180	*371-3180	18	18	89	45	131,97
*371-2200	*371-3200	20	20	100	45	167,76
SUPER PROMO VALIDA FINO AD ESAURIMENTO SCORTE:						
371-2010		1	4	50	3	11,43
371-2020		2	4	50	6	11,43
371-2030		3	6	50	10	17,14
371-2040		4	6	50	15	17,14
371-2060		6	6	50	20	17,14
371-2080		8	8	63	25	21,43
371-2100		10	10	75	25	28,57

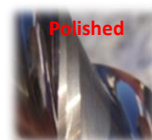
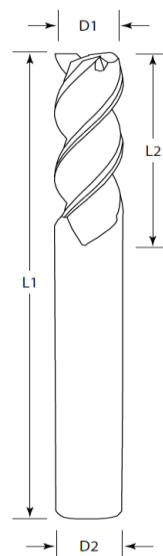

www.minosrl.com

commerciale@minosrl.com

Tel. +39 089 337885

351 – Acciai, Superleghe – 50-55Hrc - HPC



Z4 *a richiesta	D1	D2	L1	L2	Riv. T HP
SUPER PROMO VALIDA FINO AD ESAURIMENTO SCORTE					
351-4060-T	6	6	50	13	21,43
351-4080-T	8	8	63	19	28,57
351-4100-T	10	10	75	22	35,71
351-4120-T	12	12	75	26	42,86
351-4140-T	14	14	75	26	50,00
351-4160-T	16	16	89	32	57,14

Fornibili anche non rivestite.

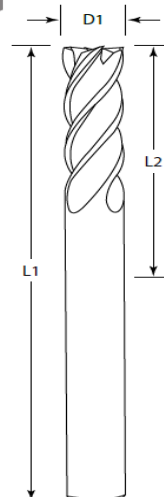

401 – Acciai, Superleghe - HFC - Elica variabile / passo differenziato



Z4 *a richiesta	D1	D2	L1	L2	Riv. J Universal HP
SUPER PROMO VALIDA FINO AD ESAURIMENTO SCORTE					
401-4030	3	6	50	8	19,97
401-4040	4	6	50	11	19,97
401-4050	5	6	50	13	19,97
401-4060	6	6	50	13	19,97
401-4080	8	8	63	19	24,73
401-4100	10	10	75	22	36,87
401-4120	12	12	75	26	44,93

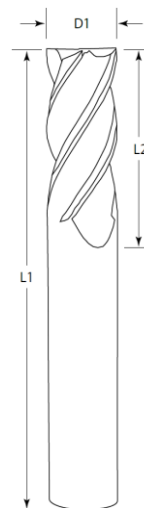

411 – Inox, Acciai, Superleghe - HFC - Elica variabile / passo differenziato

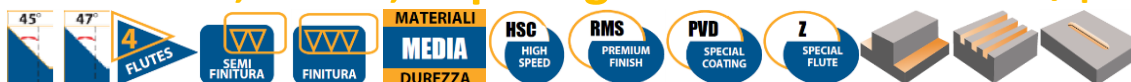

Z4 *a richiesta	D1	D2	L1	L2	Riv. J Universal HP	NON RIV
411-4030	3	6	50	8		8,57
411-4040	4	6	50	11		8,57
411-4030-J	3	6	50	8	26,63	
411-4040-J	4	6	50	11	26,63	
411-4050-J	5	6	50	13	26,63	
411-4060-J	6	6	50	13	26,63	
411-4080-J	8	8	63	19	32,97	
411-4100-J	10	10	75	22	49,16	
411-4120-J	12	12	75	26	59,90	

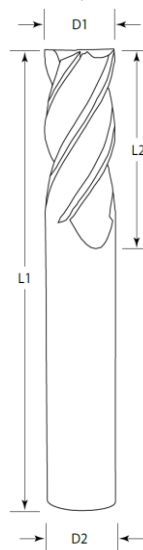

372 – Alluminio - Lunghezza Standard - HSC - Super Precise



Z2	Z3	D1	D2	L1	L2	CR	Non Rivestite
*a richiesta	*a richiesta						
372-2010-01	*372-3010-01	1	4	50	3	0.1	19,10
372-2020-02	*372-3020-02	2	4	50	6	0.2	19,10
372-2030-02	*372-3030-02	3	6	50	10	0.2	24,09
372-2040-02	*372-3040-02	4	6	50	15	0.2	24,09
372-2040-05	*372-3040-05	4	6	50	15	0.5	24,09
372-2050-02	372-3050-02	5	6	50	20	0.2	24,09
372-2050-05	372-3050-05	5	6	50	20	0.5	24,09
372-2060-02	372-3060-02	6	6	50	20	0.2	24,09
372-2060-05	372-3060-05	6	6	50	20	0.5	24,09
*372-2060-10	372-3060-10	6	6	50	20	1.0	24,09
*372-2080-02	372-3080-02	8	8	63	25	0.2	29,83
*372-2080-05	372-3080-05	8	8	63	25	0.5	29,83
*372-2080-10	372-3080-10	8	8	63	25	1.0	29,83
*372-2080-20	372-3080-20	8	8	63	25	2	29,83
*372-2100-02	372-3100-02	10	10	75	25	0.2	39,33
*372-2100-05	372-3100-05	10	10	75	25	0.5	39,33
*372-2100-10	372-3100-10	10	10	75	25	1.0	39,33
*372-2100-20	372-3100-20	10	10	75	25	2.0	39,33
*372-2120-02	372-3120-02	12	12	75	30	0.2	56,10
*372-2120-05	372-3120-05	12	12	75	30	0.5	56,10
*372-2120-10	372-3120-10	12	12	75	30	1.0	56,10
*372-2120-20	372-3120-20	12	12	75	30	2.0	56,10
*372-2140-02	372-3140-02	14	14	75	30	0.2	67,70
*372-2140-05	372-3140-05	14	14	75	30	0.5	67,70
*372-2140-10	372-3140-10	14	14	75	30	1.0	67,70
*372-2140-20	372-3140-20	14	14	75	30	2.0	67,70
*372-2160-02	372-3160-02	16	16	89	35	0.2	108,70
*372-2160-05	372-3160-05	16	16	89	35	0.5	108,70
*372-2160-10	372-3160-10	16	16	89	35	1.0	108,70
*372-2160-20	372-3160-20	16	16	89	35	2.0	108,70
*372-2180-02	*372-3180-02	18	18	89	45	0.2	145,16
*372-2180-05	*372-3180-05	18	18	89	45	0.5	145,16
*372-2180-10	*372-3180-10	18	18	89	45	1.0	145,16
*372-2180-20	*372-3180-20	18	18	89	45	2.0	145,16
*372-2200-02	*372-3200-02	20	20	100	45	0.2	184,53
*372-2200-05	*372-3200-05	20	20	100	45	0.5	184,53
*372-2200-10	*372-3200-10	20	20	100	45	1.0	184,53
*372-2200-20	*372-3200-20	20	20	100	45	2.0	184,53

SUPER PROMO VALIDA FINO AD ESAURIMENTO SCORTE

372-2010-01		1	4	50	3	0.1	14,33
372-2020-02		2	4	50	6	0.2	14,33
372-2030-02		3	6	50	10	0.2	18,06
372-2040-01		4	6	50	15	0.2	18,06
372-2040-02		4	6	50	15	0.2	18,06
372-2040-05		4	6	50	15	0.5	18,06
372-2050-02		5	6	50	20	0.2	18,06
372-2050-05		5	6	50	20	0.5	18,06
372-2060-02		6	6	50	20	0.2	18,06
372-2060-05		6	6	50	20	0.5	18,06
	372-3060-10	6	6	50	20	1.0	42,14
372-2080-02		8	8	63	25	0.2	52,19
372-2080-05		8	8	63	25	0.5	52,19
372-2080-10		8	8	63	25	1.0	52,19
372-2100-02		10	10	75	25	0.2	68,81
372-2120-02		12	12	75	30	0.2	98,17
372-2120-10		12	12	75	30	1.0	98,17

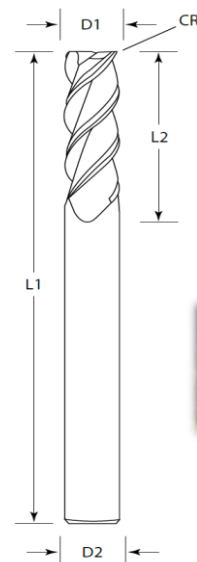

379 – Alluminio - Extra Lunghe - HSC - Super Precise



Z3	D1	D2	D2	L1	L2	L3	CR	Non Rivestite
379-3060-02	6	6	5.6	75	6	30	0.2	32,41
379-3060-05	6	6	5.6	75	6	30	0.5	32,41
379-3060-10	6	6	5.6	75	6	30	1.0	32,41
379-3080-02	8	8	7.6	75	8	45	0.2	43,49
379-3080-05	8	8	7.6	75	8	45	0.5	43,49
379-3080-10	8	8	7.6	75	8	45	1.0	43,49
379-3100-02	10	10	9.6	100	10	50	0.2	57,87
379-3100-05	10	10	9.6	100	10	50	0.5	57,87
379-3100-10	10	10	9.6	100	10	50	1.0	57,87
379-3120-02	12	12	11.6	100	12	55	0.2	78,39
379-3120-05	12	12	11.6	100	12	55	0.5	78,39
379-3120-10	12	12	11.6	100	12	55	1.0	78,39
379-3120-20	12	12	11.6	100	12	55	2.0	78,39
SUPER PROMO VALIDA FINO AD ESAURIMENTO SCORTE								
379-3060-02	6	6	5.6	75	6	30	0.2	24,31
379-3060-10	6	6	5.6	75	6	30	1.0	24,31
379-3080-02	8	8	7.6	75	8	45	0.2	32,61
379-3100-02	10	10	9.6	100	10	50	0.2	43,40
379-3120-02	12	12	11.6	100	12	55	0.2	58,79
379-3120-05	12	12	11.6	100	12	55	0.5	58,79
379-3120-10	12	12	11.6	100	12	55	1.0	58,79
379-3120-20	12	12	11.6	100	12	55	2.0	58,79

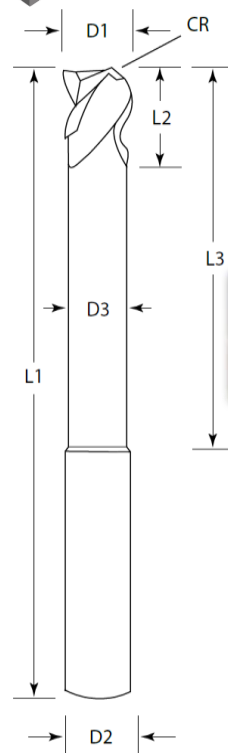

382 – Alluminio - Lunghe - HSC - Super Precise



Z3	D1	D2	D2	L1	L2	L3	CR	Non Rivestite
382-3060-02	6	6	5.6	50	6	15	0.2	32,41
382-3060-05	6	6	5.6	50	6	15	0.5	32,41
382-3060-10	6	6	5.6	50	6	15	1.0	32,41
382-3080-02	8	8	7.6	63	8	30	0.2	41,60
382-3080-05	8	8	7.6	63	8	30	0.5	41,60
382-3080-10	8	8	7.6	63	8	30	1.0	41,60
382-3100-02	10	10	9.6	75	10	35	0.2	55,36
382-3100-05	10	10	9.6	75	10	35	0.5	55,36
382-3100-10	10	10	9.6	75	10	35	1.0	55,36
382-3120-02	12	12	11.6	75	12	40	0.2	74,97
382-3120-05	12	12	11.6	75	12	40	0.5	74,97
382-3120-10	12	12	11.6	75	12	40	1.0	74,97
SUPER PROMO VALIDA FINO AD ESAURIMENTO SCORTE								
382-3060-10	6	6	5.6	50	6	15	1.0	24,31
382-3080-10	8	8	7.6	63	8	30	1.0	31,20
382-3100-10	10	10	9.6	75	10	35	1.0	41,51
382-3120-10	12	12	11.6	75	12	40	1.0	56,23

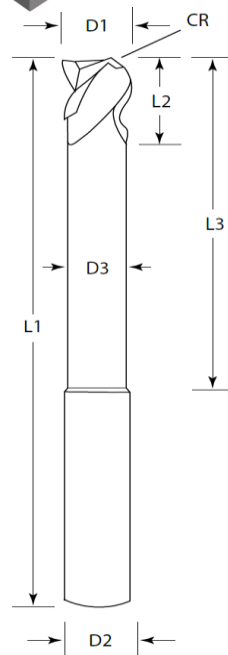

402 – Acciai, Superleghe - HFC - Elica variabile / passo differenziato

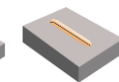

Z4 *a richiesta	D1	D2	L1	L2	CR	Riv. J Universal HP
SUPER PROMO VALIDA FINO AD ESAURIMENTO SCORTE						
402-4030-02	3	6	50	8	0.2	21,63
402-4040-02	4	6	50	11	0.2	21,63
402-4040-05	4	6	50	11	0.5	21,63
402-4050-02	5	6	50	13	0.2	21,63
402-4050-05	5	6	50	13	0.5	21,63
402-4060-02	6	6	50	13	0.2	21,63
402-4060-05	6	6	50	13	0.5	21,63
402-4080-02	8	8	63	19	0.2	26,76
402-4080-05	8	8	63	19	0.5	26,76
402-4100-02	10	10	75	22	0.2	39,56
402-4100-05	10	10	75	22	0.5	39,56
402-4100-10	10	10	75	22	1.0	39,56
402-4120-02	12	12	75	26	0.2	48,81
402-4120-05	12	12	75	26	0.5	48,81
402-4120-10	12	12	75	26	1.0	48,81
402-4140-02	14	14	75	26	0.2	60,44
402-4140-05	14	14	75	26	0.5	60,44
402-4140-10	14	14	75	26	1.0	60,44
402-4160-02	16	16	89	32	0.2	92,76
402-4160-05	16	16	89	32	0.5	92,76
402-4160-10	16	16	89	32	1.0	92,76

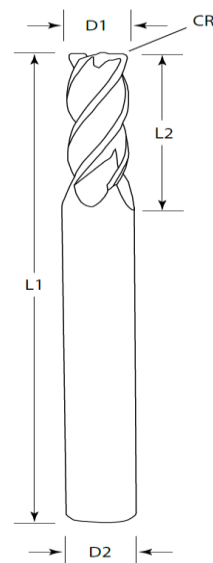

402-L3 – Acciai, Superleghe - HFC - Elica variabile / passo differenziato

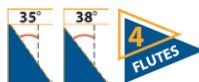

Z4 *a richiesta	D1	D2	L1	L2	L3	CR	J Universal HP
SUPER PROMO VALIDA FINO AD ESAURIMENTO SCORTE							
402-4060-02-L3-J	6	6	50	13	20	0.2	26,61
402-4060-05-L3-J	6	6	50	13	20	0.5	26,61
402-4080-02-L3-J	8	8	63	19	30	0.2	35,67
402-4080-05-L3-J	8	8	63	19	30	0.5	35,67
402-4100-02-L3-J	10	10	75	22	35	0.2	49,90
402-4100-05-L3-J	10	10	75	22	35	0.5	49,90
402-4100-10-L3-J	10	10	75	22	35	1.0	49,90
402-4120-02-L3-J	12	12	75	26	40	0.2	58,17
402-4120-05-L3-J	12	12	75	26	40	0.5	58,17
402-4120-10-L3-J	12	12	75	26	40	1.0	58,17
402-4140-02-L3-J	14	14	75	26	40	0.2	69,26
402-4140-05-L3-J	14	14	75	26	40	0.5	69,26
402-4140-10-L3-J	14	14	75	26	40	1.0	69,26
402-4160-02-L3-J	16	16	89	32	50	0.2	106,93
402-4160-05-L3-J	16	16	89	32	50	0.5	106,93
402-4160-10-L3-J	16	16	89	32	50	1.0	106,93

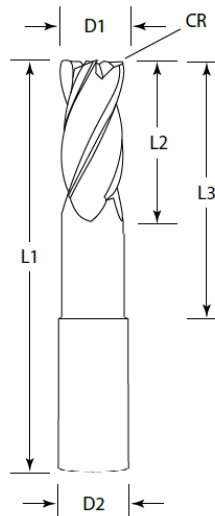

412 – Inox, Acciai, Superleghe

HFC - Elica variabile / passo differenziato



Z4 *a richiesta	D1	D2	L1	L2	CR	Riv. J Universal HP
412-4030-02	3	6	50	8	0.2	28,83
412-4040-02	4	6	50	11	0.2	28,83
412-4040-05	4	6	50	11	0.5	28,83
412-4050-02	5	6	50	13	0.2	28,83
412-4050-05	5	6	50	13	0.5	28,83
412-4060-02	6	6	50	13	0.2	28,83
412-4060-05	6	6	50	13	0.5	28,83
412-4080-02	8	8	63	19	0.2	35,69
412-4080-05	8	8	63	19	0.5	35,69
412-4100-02	10	10	75	22	0.2	52,74
412-4100-05	10	10	75	22	0.5	52,74
412-4100-10	10	10	75	22	1.0	52,74
412-4120-02	12	12	75	26	0.2	65,09
412-4120-05	12	12	75	26	0.5	65,09
412-4120-10	12	12	75	26	1.0	65,09
412-4140-02	14	14	75	26	0.2	80,60
412-4140-05	14	14	75	26	0.5	80,60
412-4140-10	14	14	75	26	1.0	80,60
412-4160-02	16	16	89	32	0.2	123,69
412-4160-05	16	16	89	32	0.5	123,69
412-4160-10	16	16	89	32	1.0	123,69
*412-4200-02	20	20	100	38	0.2	205,40
*412-4200-05	20	20	100	38	0.5	205,40
*412-4200-10	20	20	100	38	1.0	205,40

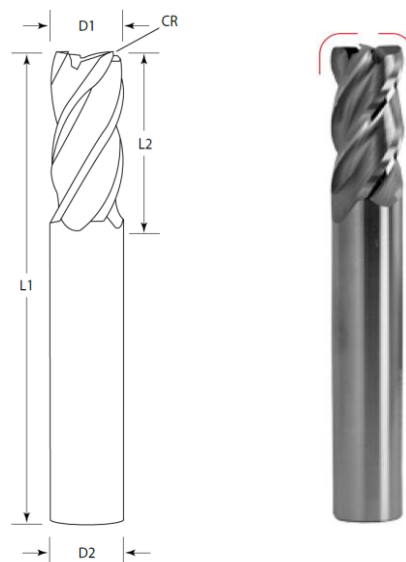

416 – Titanio – Inox – HFC - Elica variabile / passo differenziato



Z5 *a richiesta	D1	D2	D3	L1	L2	L3	CR	Riv. T HP
SUPER PROMO VALIDA FINO AD ESAURIMENTO SCORTE								
416-5060-05-T	6	6	5.6	50	13	20	0.5	14,29
416-5080-05-T	8	8	7.6	63	19	30	0.5	21,43
416-5080-10-T	8	8	7.6	63	19	30	1.0	21,43
416-5080-15-T	8	8	7.6	63	19	30	1.5	21,43
416-5100-15-T	10	10	9.6	75	22	35	1.5	28,57
416-5100-20-T	10	10	9.6	75	22	35	2.0	28,57
416-5120-10-T	12	12	11.6	75	26	40	1.0	35,71
416-5120-15-T	12	12	11.6	75	26	40	1.5	35,71
416-5120-20-T	12	12	11.6	75	26	40	2.0	35,71
416-5160-10-T	16	16	15.6	100	35	50	1.0	57,14
416-5160-15-T	16	16	15.6	100	35	50	1.5	57,14
416-5160-20-T	16	16	15.6	100	35	50	2.0	57,14
416-5160-30-T	16	16	15.6	100	35	50	3.0	57,14
416-5160-40-T	16	16	15.6	100	35	50	4.0	57,14

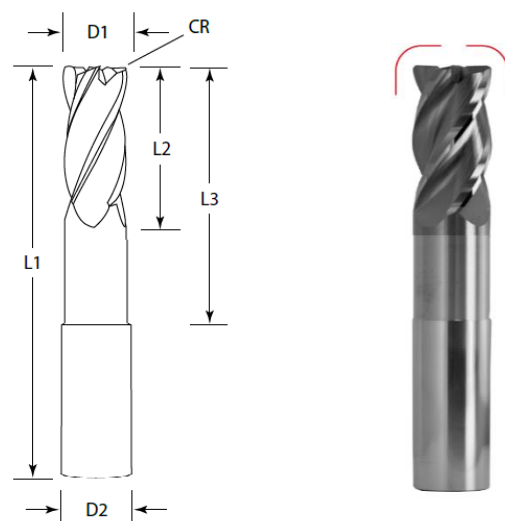

409 – Acciai, Superleghe - HFC - Elica variabile / passo differenziato



Z4 *a richiesta	D1	D2	D3	L1	L2	L3	CR	Riv. J Universal HP
SUPER PROMO VALIDA FINO AD ESAURIMENTO SCORTE								
409-4040-02	4	4	3.8	100	10.0	50	0.2	19,77
409-4050-02	5	6	5.6	100	13.0	50	0.2	24,33
409-4050-05	5	6	5.6	100	13.0	50	0.5	24,33
409-4060-02	6	6	5.6	100	13.0	50	0.2	24,33
409-4060-05	6	6	5.6	100	13.0	50	0.5	24,33
409-4080-02	8	8	7.6	100	19.0	50	0.2	30,11
409-4080-05	8	8	7.6	100	19.0	50	0.5	30,11
409-4100-02	10	10	9.6	125	22.0	65	0.2	65,80
409-4100-05	10	10	9.6	125	22.0	65	0.5	65,80
409-4100-10	10	10	9.6	125	22.0	65	1.0	65,80
409-4120-02	12	12	11.6	150	26.0	75	0.2	90,41
409-4120-05	12	12	11.6	150	26.0	75	0.5	90,41
409-4120-10	12	12	11.6	150	26.0	75	1.0	90,41
409-4160-05	16	16	15.6	150	32.0	75	0.5	121,00

Per specificare il tipo di rivestimento aggiungere la lettera alla fine del codice.
Fornibili anche non rivestite.

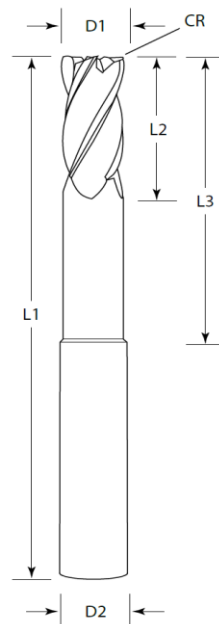

352 – Acciai, Superleghe – 50-55Hrc - HPC

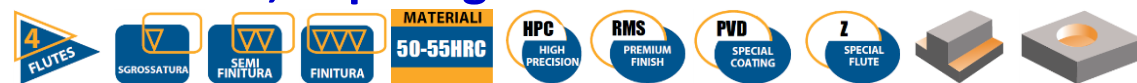

Z4 *a richiesta	D1	D2	L1	L2	CR	Riv. T HP
SUPER PROMO VALIDA FINO AD ESAURIMENTO SCORTE						
352-4010-01-T	1	6	50	3	0.1	14,29
352-4015-01-T	1.5	6	50	5	0.1	14,29
352-4020-01-T	2	6	50	6	0.1	14,29
352-4030-02-T	3	6	50	8	0.2	21,43
352-4040-02-T	4	6	50	11	0.2	21,43
352-4040-05-T	4	6	50	11	0.5	21,43
352-4050-02-T	5	6	50	13	0.2	21,43
352-4050-05-T	5	6	50	13	0.5	21,43
352-4060-03-T	6	6	50	13	0.3	21,43
352-4060-05-T	6	6	50	13	0.5	21,43
352-4080-03-T	8	8	63	19	0.3	28,57
352-4080-05-T	8	8	63	19	0.5	28,57
352-4100-05-T	10	10	75	22	0.5	35,71
352-4120-05-T	12	12	75	26	0.5	42,86
352-4140-05-T	14	14	75	26	0.5	42,86
352-4160-05-T	16	16	89	32	0.5	50,00

Fornibili anche non rivestite.

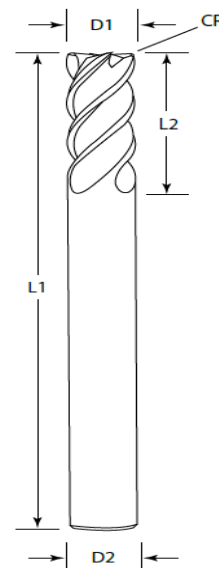

373 – Alluminio - Lunghezza Standard - HSC - Super Precise



Z2	D1	D2	D3	L1	L2	L3	R	Non Rivestite
373-2010	1	4.0	0.96	50	1	8	0.5	26,04
373-2020	2	4.0	1.92	50	2	10	1	26,04
373-2030	3	6.0	2.9	50	3	10	1.5	29,33
373-2040	4	6.0	3.8	50	4	12	2	29,33
373-2050	5	6.0	4.8	50	5	16	2.5	29,33
373-2060	6	6.0	5.6	50	6	20	3	29,33
373-2080	8	8.0	7.6	63	8	30	4	36,30
373-2100	10	10.0	9.6	75	10	35	5	47,91
373-2120	12	12.0	11.6	75	12	35	6	68,36
SUPER PROMO VALIDA FINO AD ESAURIMENTO SCORTE								
373-2020	2	4.0	1.92	50	2	10	1	14,29
373-2050	5	6.0	4.8	50	5	16	2.5	21,43
373-2060	6	6.0	5.6	50	6	20	3	21,43
373-2120	12	12.0	11.6	75	12	35	6	50,00

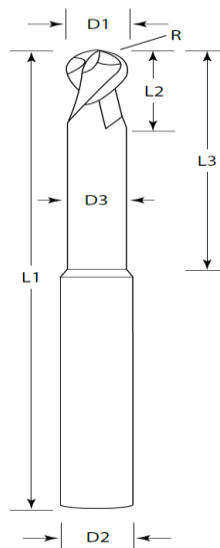

383 – Alluminio - Lunghe - HSC - Super Precise



Z2 *a richiesta	D1	D2	D3	L1	L2	L3	CR	Non Rivestite
SUPER PROMO VALIDA FINO AD ESAURIMENTO SCORTE								
383-2030	3	6	2.9	75	3	12	1.5	26,59
383-2040	4	6	3.8	75	4	16	2	26,59
383-2050	5	6	4.8	75	5	20	2.5	26,59
383-2060	6	6	5.6	75	6	24	3	26,59
383-2080	8	8	7.6	75	8	32	4	34,66
383-2100	10	10	9.6	100	10	40	5	42,66
383-2120	12	12	11.6	100	12	48	6	60,79

Per ordinare rivestite (fornibili a richiesta), aggiungere la lettera -L o -ZF alla fine del codice.

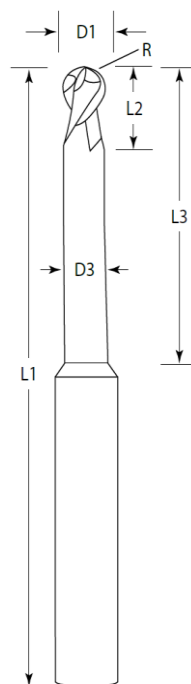

353 – Acciai, Superleghe – 50-55Hrc - HPC

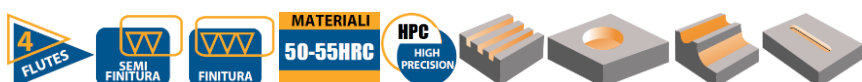

Z4	D1	D2	L1	L2	R	Riv. T HP
SUPER PROMO VALIDA FINO AD ESAURIMENTO SCORTE						
353-4030-T	3	6	50	4	1.5	14,29
353-4040-T	4	6	50	6	2	21,43
353-4050-T	5	6	50	7	2.5	21,43
353-4060-T	6	6	50	9	3	21,43
353-4080-T	8	8	63	12	4	35,71
353-4100-T	10	10	75	15	5	35,71
353-4120-T	12	12	75	18	6	50,00

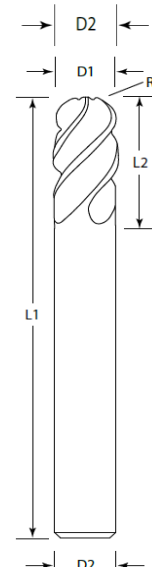

403 – Acciai, Superleghe - HFC Elica variabile / passo differenziato



Z4 *a richiesta	D1	D2	D3	L1	L2	L3	R	Riv. J Universal HP
403-4010-T	1	4	0.96	50	1.5	8	0.5	29,50
403-4020-T	2	4	1.92	50	3.0	10	1	29,50
403-4030-J	3	6	2.9	50	4.5	10	1.5	33,30
403-4040-J	4	6	3.8	50	6.0	12	2	33,30
403-4050-J	5	6	4.8	50	7.5	16	2.5	33,30
403-4060-J	6	6	5.6	50	9.0	20	3	33,30
403-4080-J	8	8	7.6	63	12.0	30	4	41,40
403-4100-J	10	10	9.6	75	15.0	35	5	54,71
403-4120-J	12	12	11.6	75	18.0	35	6	76,46
403-4160-J	16	16	15.6	89	24.0	40	8	139,20
*403-4200-J	20	20	19.6	100	38.0	55	10	232,50

Per specificare il tipo di rivestimento aggiungere la lettera alla fine del codice. Fornibili anche non rivestite.

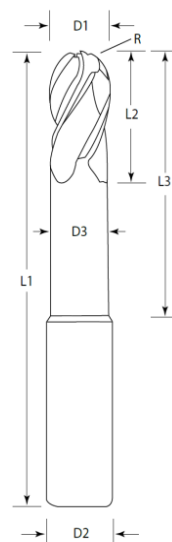

410 – Acciai, Superleghe – Lunghe

HFC Elica variabile / passo differenziato



Z4 *a richiesta	D1	D2	D3	L1	L2	L3	R	Riv. J Universal HP
SUPER PROMO VALIDA FINO AD ESAURIMENTO SCORTE								
410-4040	4	4	3.8	100	10	50	2	19,77
410-4050	5	6	4.6	100	13	50	2.5	24,33
410-4060	6	6	5.6	100	13	50	3	24,33
410-4080	8	8	7.6	100	19	50	4	30,11
410-4100	10	10	9.6	125	22	65	5	65,80
410-4120	12	12	11.6	150	26	75	6	90,41

Per specificare il tipo di rivestimento aggiungere la lettera alla fine del codice. Fornibili anche non rivestite.

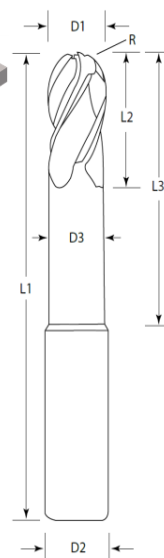

413 – Inox, Acciai, Superleghe

HFC - Elica variabile / passo differenziato



Z4	D1	D2	D3	L1	L2	L3	R	Riv. J Universal HP
413-4010-T	1	4	0.96	50	1.5	8	0.5	22,13
413-4020-T	2	4	1.92	50	3	10	1	22,13
413-4030-J	3	6	2.9	50	4.5	10	1.5	24,97
413-4040-J	4	6	3.8	50	6	12	2	24,97
413-4050-J	5	6	4.8	50	7.5	16	2.5	24,97
413-4060-J	6	6	5.6	50	9	20	3	24,97
413-4080-J	8	8	7.6	63	12	30	4	31,04
413-4100-J	10	10	9.6	75	15	35	5	41,04
413-4120-J	12	12	11.6	75	18	35	6	57,34

